



# Operators Guide LPA3

## Portable Particle Counter





# PRODUCT OVERVIEW

## LPA3 - Portable Particle Counter

MP Filtri's new LPA3 is one of the most advanced portable particle counters in the world. Whether you are working in the lab or in the field, the LPA3 delivers a fast, accurate and comprehensive hydraulic health check in a robust yet portable package.

Its real-time monitoring and predictive maintenance technology safeguards machinery, enhances performance and productivity, and reduces costs and unplanned downtime. Featuring the latest breakthroughs in optical and photodiode technology, the new LPA3 enhances the reliability and longevity of complex hydraulic systems and is ideal for quality control in in-house manufacturing applications. The LPA3 is compatible with the full range of Bottle Samplers.

### Features & Benefits

- Online/realtime monitoring
- Comprehensive hydraulic health check
- Proactive maintenance capabilities
- High-speed sample times
- Programmable 10.1" (25.6 cm) touchscreen display
- Perfectly portable at just 14 kg
- Programmable sample volumes
- Precision instrument
- Live trend analysis option
- Measures and displays the following international standard formats:  
ISO 4406, NAS 1638, AS 4059E&F, GBT 14039, GJB420B
- Moisture and temperature sensing
- Data logging and enhanced 4000 test result memory
- Key performance information at a glance
- LPA View software (included)
- Ideal for hydraulic, lubrication, and subsea fluids
- Integrated printer option
- Full accessories kit included
- Long-life Lithium Ion battery



## Product Presentation

The LPA3 measures and quantifies the numbers of solid contaminants in Hydraulic, Lubrication and Transmission applications. The unit is designed to be an accurate instrument for applications utilising mineral oil as the operating fluid. Other fluid media versions are available for offshore [N] and aerospace phosphate ester [S] applications.

The unit can operate using any of the international standard formats ISO 4406, NAS 1638, AS 4059 revisions E and F, ISO 11218, GJB420B, GBT14039.

The LPA3 incorporates an IP rated connector for power as well as separate USB connections for computer remote monitoring/settings access and direct download to a USB memory stick.

The integrated data logger records up to 4000 test results internally, for use where a computer cannot be permanently connected.

The instrument utilises the light extinction principle whereby a specially collimated precision LED light source is used to illuminate the test media, this light is then captured via a photodiode module. When a particle passes through the beam it reduces the amount of light received by the diode, and from this change in condition, the size of the particle can be deduced and subsequently counted.

### Benefits

- A programmable 10.1" full colour touch-screen LCD display for clear visual indication of results
- High speed sample times up to 15 times faster than LPA2
- Instant results download via USB
- Proactive maintenance technology
- Online real-time monitoring
- Long-life lithium ion battery
- Optional thermal printer for an instant hard copy of results
- Optional Moisture and temperature sensor

### Product features

#### Moisture sensor

LPA3-W models measure water content using a capacitive RH (relative humidity) sensor. The result is expressed as percentage saturation. 100% RH corresponds to the point at which free water exists in the fluid, i.e. the fluid is no longer able to hold the water in a dissolved solution. This is also normally the point at which significant damage occurs in a hydraulic system, so is an ideal measurement scale that is independent of the fluid characteristics.

The water saturation point (100% RH) is temperature dependent, so the temperature is measured at the same time. This enables results to be compared meaningfully.

The temperature measured is that of the fluid passing through the unit.

Note: this may differ from that of the hydraulic system, depending on flow rate, pipe length and ambient temperature. It is not intended to be an accurate indication of system temperature, but to provide a reference for the RH measurement at the point of sample. Nevertheless, experience has shown the temperature measured is within a few degrees of that of the hydraulic system, in most applications.

# PRODUCT OVERVIEW

## Data logger

The LPA3 includes a built-in data logger, which adds the facility to log and timestamp test results locally within an internal memory, even when not connected to a computer.

- Test logging is determined by the log settings
- Each log entry is time-stamped and contains the LPA3 serial number, so that it can be identified later.
- The LPA3 memory has space for around 4000 log entries. When full, the oldest log entry is overwritten.

## Data transfer via USB stick

All versions of the LPA3 allow direct download via a USB memory stick. With the LPA3 powered ON, plug the USB stick into the USB connector on the side of the unit.

The USB stick icon appears on the right-hand side of the screen when the stick is plugged in. The arrow icon pointing to the icon is visible when the LPA3 tries to write the log file to the stick. A successful download is denoted by a green tick emblem. If the download fails, a red cross icon will appear. If this error is present, the memory stick may need to be re-formatted (formatting should be done to FAT32).

The icon will remain visible until the USB stick is removed, at which point all the icons associated with the USB download function disappear.

The USB stick provided with the unit is pre-formatted for the transfer. Other USB sticks may need to be re-formatted (FAT32 or FAT32Ex filesystems, this is normal for file transfers between Windows systems and devices).

## Optional built-in pressure transducer

LPA30P & LPA3WP models measure system pressure at inlet of the unit via a built in 0-600 bar pressure transducer with a sensor accuracy of +/-0.5% Full scale.

This transducer can be used to ensure a test is performed at sufficient pressure (see page 19). Reading on screen can be chosen in either bar or psi by the touch of a button

## Optional on-board thermal printer

Options within the product code allow for the choice of an on-board printer. Instant result via the USB download gives a fast-digital copy where the printer provides a hard copy for files and written reports.

## Fluid compatibility product versions

Options within the product code allow for a tailored product to suit and be compatible for a range of fluids.

**M and MW version:** Mineral and synthetic oils, plus diesel fluids

**N version:** Offshore/Subsea and water-based fluids

**S version:** Phosphate ester and aggressive fluids.

## Disclaimer

As a policy of continual improvement, MP Filtri reserves the right to alter the specification without prior notice.



# DECLARATION OF CONFORMITY

## **EC Declaration of Conformity**

The products included in this Declaration are all variants of the following:

- With or without moisture sensor
- Compatible with mineral oil/ synthetic fluids, offshore fluids.
- With or without printer
- With USB download
- With/without pressure transducer
- With touchscreen display

For part codes see the Designation & Ordering Code (section 4.8 on page 20).

Product Manufacturer:

MP Filtri UK  
Bourton Industrial Estate  
Bourton on the Water  
Cheltenham  
Gloucestershire  
GL54 2HQ  
01451 822522  
sales@mpfiltri.co.uk

The products described are in conformity with the following directives:

2014/30/EU Electromagnetic Conformity

Certification Testing that has been carried out is in accordance with:

- DEF STAN 00-35 Part 3 issue 4 Environmental Test Methods
- BS EN 60068 range of standards covering environmental conditions
- BS EN 60529: 1992 + A2:2013 Degrees of Protection provided by enclosures (IP Code)
- BS EN 62262:2002 Degrees of Protection Provided for Electrical Equipment against External Mechanical Impacts (IK Code)
- BS EN 60721-3-4: 1995 Part 3: Classification of Groups of Environmental Parameters and their severities, Section 3.4

Date: July 2020

Signed:

Phil Keep (Managing Director) on behalf of MP Filtri UK Ltd



|   | Pg.       |
|---|-----------|
| <b>Product overview</b>   | <b>1</b>  |
| EC Declaration of Conformity  | 5         |
| Table of Contents   | 6         |
| What this guide is for  | 8         |
| <br>  |           |
| <b>1 General warnings and information for the Operator</b>                            | <b>10</b> |
| 1.1 General safety warnings   | 10        |
| 1.2 Operator position and dangerous areas   | 12        |
| 1.3 Dangers and Hazards that cannot be eliminated                                     | 12        |
| 1.4 Personal Protective Equipment   | 12        |
| 1.5 Precautions related to product handling of the Liquid Crystal Touchscreen display | 13        |
| <br>  |           |
| <b>2 Transportation and Storage</b>   | <b>15</b> |
| 2.1 Transportation and Handling Conditions  | 15        |
| 2.2 Storage   | 15        |
| <br>  |           |
| <b>3 Warranty, Limitations and Disclaimers</b>  | <b>16</b> |
| <br>  |           |
| <b>4 Technical Specification</b>  | <b>18</b> |
| 4.1 Performance   | 18        |
| 4.2 Electrical Interface  | 18        |
| 4.3 Physical Attributes   | 19        |
| 4.4 Fluid Characteristics   | 19        |
| 4.5 Environment   | 19        |
| 4.6 Dimensions  | 20        |
| 4.7 Designation & Ordering code   | 20        |
| <br>  |           |
| <b>5 Product Installation and General Operation</b>                                   | <b>21</b> |
| 5.1 Installation  | 21        |
| 5.1.1 Physical Procedure  | 22        |
| 5.1.2 Electrical Interface  | 23        |
| 5.2 General Operation   | 24        |
| 5.2.1 Physical Checks   | 24        |
| 5.2.2 Front Panel Operation and calibration due date                                  | 24        |
| 5.2.3 Home Screen   | 25        |
| 5.2.4 Test Reference Icon   | 26        |
| 5.2.5 Test Format Icon  | 26        |
| 5.2.6 Last Test Result  | 26        |
| 5.2.7 Detailed Results Viewer   | 26        |
| 5.2.8 Pressure Readout  | 27        |
| 5.2.9 RH result   | 27        |
| 5.2.10 Temperature Result   | 27        |
| 5.2.11 Battery Status Change  | 27        |
| 5.2.12 Power Icon   | 27        |
| 5.2.13 Contrast Slider Icon   | 27        |
| 5.2.14 Cleanliness Level Settings Icon  | 27        |
| 5.2.15 Quick Help Icon  | 30        |
| 5.2.16 Historical Results Section   | 30        |

# TABLE OF CONTENTS

|                                |                                      |           |
|--------------------------------|--------------------------------------|-----------|
| 5.2.17                         | Test Type Icon                       | Pg.<br>31 |
| 5.2.18                         | Home Icon                            | 32        |
| 5.2.19                         | Test start/stop operation button     | 32        |
| 5.2.20                         | Manual Flush Operation Button        | 33        |
| 5.2.21                         | Printer Icon                         | 33        |
| 5.2.22                         | Live Pressure Reading                | 33        |
| 5.3                            | Settings Icon                        | 34        |
| 5.3.1                          | Test Reference                       | 35        |
| 5.3.2                          | Result Format                        | 35        |
| 5.3.3                          | Test Type                            | 35        |
| 5.3.3.1                        | Normal Test                          | 35        |
| 5.3.3.2                        | Continuous Test                      | 35        |
| 5.3.3.3                        | Bottle Sampling                      | 37        |
| 5.3.4                          | Flush Time                           | 37        |
| 5.3.5                          | Sample Volume Size                   | 38        |
| 5.3.6                          | Water Content (RH)                   | 38        |
| 5.3.7                          | Simulation                           | 38        |
| 5.3.8                          | Diagnostics                          | 38        |
| 5.3.9                          | Language                             | 39        |
| 5.3.10                         | Delete History                       | 39        |
| 5.3.11                         | Printer Icon                         | 39        |
| 5.4                            | LPA3 Removal and Product Maintenance | 40        |
| 5.5                            | Disposal                             | 40        |
| <b>6 Troubleshooting / FAQ</b> |                                      | <b>43</b> |
| 6.1                            | Misuse of Product                    | 43        |
| 6.2                            | Fault Finding                        | 43        |

## What this guide is for

This guide will take you through the installation and instructions for making the most out of your LPA3. It contains detailed information to enable you to master the full functionality of the device, as well as key information on safety, warranty, maintenance and accessories.

We also recommend that you check out the new installation video on our Youtube channel for help in setting up the machine. It can be found here: <https://youtu.be/Bx63GbdjxDU>.



You can also visit Youtube and search for MP Filtri LPA3 Walkthrough. At MP Filtri we are committed to customer service and hope this manual will help you to fully master the LPA3.

### Disclaimer

As a policy of continual improvement, MP Filtri reserves the right to alter the specification without prior notice.

# OPERATOR'S GUIDE

# 1 General warnings and information for the Operator

## 1.1 General Safety Warnings

Do not operate, maintain or carry out any procedure before reading this manual. Any individual operating the unit shall wear the following Personal Protective Equipment:

- Protective eyewear
- Safety shoes
- Gloves
- Overalls (or other suitable protective clothing)

Before carrying out any machine installation procedures and/or before use, one should scrupulously follow the instructions listed in this manual. Moreover, it is necessary to comply with the current regulations related to occupational accident prevention and safety in the workplace.

Notices aimed at the prevention of health hazards for personnel operating the machine are highlighted in this document with signs having the following meaning:

It relates to important information concerning the product, its use or part of this documentation to which special attention must be paid



NOTE

It means that failure to comply with the relevant safety regulations may result in mild injury or property damage.



CAUTION

It means that failure to comply with the relevant safety regulations may result in death, serious injury or serious property damage.



DANGER

Failure to comply with the relevant safety regulations may result in death, serious injury or serious property damage.

# GENERAL WARNINGS

To allow rapid identification of the employees who must read this manual, definitions have been used with the following meaning:

|  |   |
|--|---|
| OPERATOR   | This is any individual whose task is to use the machine for production purposes. The operator is aware of all the measures taken by the machine manufacturer in order to eliminate any source of injury risk in the workplace and takes into account the operational constraints.   |
| PERSONNEL INVOLVED IN SLINGING AND HOISTING OPERATIONS | This is any individual whose task is to handle the machine or parts of it. Personnel involved in slinging and hoisting operations are aware of the issues regarding the safe transfer of machinery or parts of it and, therefore, uses appropriate lifting equipment, following the instructions provided by the product manufacturer.                  |
| MACHINE SETTER   | This is any individual whose task is to set up the machine for its operation. The machine setter is aware of the measures taken to eliminate all sources of injury risks in the workplace and takes into account the operational constraints. The machine setter takes all the appropriate precautions in order to operate in utmost safety conditions. |
| MAINTENANCE TECHNICIAN                                 | This is any individual whose task is to carry out maintenance activities on the machine. The maintenance technician is aware of the possible danger situations that may arise and takes the appropriate precautions in order to eliminate the risks of accidents in the workplace.  |
| ELECTRICIAN  | This is any individual whose task is to carry out maintenance activities on the electrical wiring of the machine. The electrician is aware of the possible danger situations that may arise and takes the appropriate precautions in order to eliminate the risks of accidents in the workplace.  |

## 1.2 Operator Position and Dangerous Areas

No operator is required for operating the unit. However, the following areas are to be considered dangerous: The ones close to the electric motor because of live equipment with potentially hot surfaces.

The unit shall be taken out of service and/or dismantled in accordance with the current regulations in force in the country where the machinery is installed



NOTE

The machinery is not suitable for outdoor use and all the electrical devices have a protection class starting from IP 55 upwards.



CAUTION

## 1.3 Dangers and Hazards that cannot be eliminated

- Electric shock risk on the electric motor; in case of motor malfunction
- Burn risk because of high temperatures
- Accidental oil leaks with consequent risk of slipping
- Hose breakage and resulting lubricant loss
- With oil temperatures exceeding 40/45 °C, it is vital to be extremely careful when handling the metal lances/the hoses and when moving the unit. Avoid direct contact with hot oil and with the filter body.

ALL EQUIPMENT SHOULD BE ALLOWED TO COOL PRIOR TO HANDLING, AFTER IT HAS BEEN IN USE

## 1.4 Personal Protective Equipment

When operating the unit, personnel must be wearing safety shoes, gloves and goggles. In general, the PPEs to be used according to the activities on the machinery are listed in the following table:

| ACTIVITY            | PPE                             |
|---------------------|---------------------------------|
| Ordinary operation  | Shoes, gloves, goggles, overall |
| Planned maintenance | Shoes, gloves, goggles, overall |



# GENERAL WARNINGS

## 1.5 Precautions related to product handling of the Liquid Crystal Touchscreen display

- If the LCD panel breaks, be careful not to get the liquid crystal to touch your skin.
- If the liquid crystal touches your skin or clothes, please wash it off immediately by using soap and water.
- Avoid any strong mechanical shock which can break the glass.
- Avoid static electricity which can damage the CMOS LSI when working with the module, be sure to ground your body and any electrical equipment you may be using.
- Do not remove the panel or frame from the module.
- The polarizing plate of the display is very fragile. So, please handle it very carefully, do not touch, push or rub the exposed polarizing with anything harder than an HB pencil lead (glass, tweezers, etc.)
- Do not wipe the polarizing plate with a dry cloth, as it may easily scratch the surface of plate.
- Do not use ketonic solvent and aromatic solvent. Use with a soft cloth soaked with a cleaning naphtha solvent.
- To avoid liquid (include organic solvent) stained on LCM.
- Store LPA3 in a dark place where the temperature is  $25^{\circ}\text{C} \pm 5^{\circ}\text{C}$  and the humidity is below 65% RH.
- Do not place the module near organics solvents or corrosive gases.
- Do not crush, shake, or jolt the module.



# TRANSPORT / STORAGE

## 2 Transportation and Storage

### 2.1 Transportation and handling Conditions

The unit is shipped in a cardboard box with appropriate protective packaging and these should be recycled accordingly where possible.

The packed weight of the LPA3 and accessories is 14 kg, the box dimensions are 60 x 50 x 40 cm.

### 2.2 Storage

The unit should be stored in a suitable location away from the production area when not in use. The unit should be stored with the caps provided on the ports. This location should not impede any other production or personnel.

## 3 Warranty, Limitations and Disclaimers

MP Filtri warrants that the products that it manufactures and sells will be free from defects in material, workmanship & performance for a period of 12 months from the date of shipment.

### Hardware/Firmware

Should the hardware prove defective during the warranty period, MP Filtri, at its discretion, will either repair the defective product or replace it with an equivalent product in exchange for the defective unit without charge for parts, labour, carriage and insurance.

### Software

MP Filtri warrants that software will operate substantially in accordance with its functional specification for 12 months from date of shipment provided that the integrity of the operating environment has not been compromised through misuse, inappropriate handling, abnormal operating conditions, neglect or damage (unintentional or otherwise) or the introduction of third party product (software or hardware) that in any way conflicts with the MP Filtri product.

### Eligibility

This warranty extends to the original purchaser only or to the end-user client of a MP Filtri authorised affiliate.

### How to obtain service?

To obtain service under the terms of this warranty, the customer is required to notify MP Filtri before the expiration of the warranty period and to return the item in accordance with MP Filtri product return policy. Any product returned for warranty repair must be accompanied by a full fault report specifying the symptoms and the conditions under which the fault occurs. Should MP Filtri incur additional cost as a result of a failure to complete the appropriate paperwork, an administrative charge may be levied.

### Exclusions

This warranty shall not apply to any defect, failure or damage caused by improper use or improper or inadequate care. MP Filtri shall not be obligated to provide service under this warranty if:

- a) Damage has been caused by a failure to make a full and proper inspection of the product (as described by the documentation enclosed with the product at the time of shipment) on initial receipt of the product following shipment;
- b) Damage has been caused by the attempts of individuals, other than MP Filtri staff to repair or service the product;
- c) Damage has been caused by the improper use or a connection with incompatible equipment or product including software applications.

### Charges

Under cover of this warranty, MP Filtri will pay the carriage and insurance charges for the shipment of defective product back to site of manufacture and for its return to the client's original site of despatch except when:

- a) MP Filtri product return policy has not been followed.
- b) Product failure is caused by any of the exclusions described above, when the customer will be liable for the full cost of the repair (parts and labour) plus all carriage and insurance costs to and from MP Filtri premises.
- c) The product is damaged in transit and a contributory cause is inadequate packaging. It is the customer's responsibility to ensure that the packaging used to return equipment to MP Filtri is the same, or has equivalent protective qualities, to that used to ship the product to the customer in the first instance. Any damage resulting from the use of inadequate packaging will nullify MP Filtri

# WARRANTY

obligations under this warranty. Should the customer's product be damaged in transit following a repair at MP Filtri site, a full photographic record of the damage must be obtained (packaging and the product) to support any claim for recompense. Failure to present this evidence may limit MP Filtri obligations under this warranty.

THIS WARRANTY IS GIVEN BY MP FILTRI IN LIEU OF ANY OTHER WARRANTIES, EXPRESS OR IMPLIED, INCLUDING BUT NOT LIMITED TO ANY IMPLIED WARRANTY OF MERCHANTABILITY, NON INFRINGEMENT OR FITNESS FOR A PARTICULAR PURPOSE. MP FILTRI LTD SHALL NOT BE LIABLE FOR ANY SPECIAL, INDIRECT, INCIDENTAL OR CONSEQUENTIAL DAMAGES OR LOSSES ( INCLUDING LOSS OF DATA), WE SPECIFICALLY DISCLAIM ANY AND ALL WARRANTIES TO CUSTOMERS OF THE CUSTOMER. THE CUSTOMER'S SOLE REMEDY FOR ANY BREACH OF WARRANTY IS THE REPAIR OR REPLACEMENT, AT MP FILTRI DISCRETION, OF THE FAILED PRODUCT.

MP Filtri Ltd maintains a policy of product improvement and reserves the right to modify the specifications without prior notice.

## 3.1 Warranty on Recalibration

The LPA3 is guaranteed for 12 months upon receipt of the LPA3, subject to it being used for the purpose intended and operated in accordance with this User Guide.

MP Filtri UK will only verify the accuracy of the LPA3 if the unit is recalibrated every 12 months.

Please ensure that the test results in the Log are downloaded to LPA-View before the LPA3 is despatched, in case action taken by MP Filtri UK during the service / recalibration causes the Log to be cleared.



**NOTE**

It is requested that only the LPA3, not the support case or any other ancillaries, be returned for recalibration. MP Filtri UK will not be held responsible for any items returned as such. Ensure that the LPA3 is packed appropriately for transportation.

## 4. Technical Specification

### 4.1 Performance

|                                    |  |
|------------------------------------|--|
| Technology                         | High precision LED light extinction automatic optical particle counter   |
| Particle Sizing                    | >4, 6, 14, 21, 25, 38, 50, 70 $\mu\text{m}$  |
| Analysis range                     | ISO 4406 Codes 8 to 24<br>NAS 1638 Class 2 to 12<br>AS4059/ISO 11218 Rev E, Table 1 Size Codes 2-12<br>AS4059/ISO 11218 Rev E, Table 2 Size Codes, A: 000 to 12, B: 00 to 12, C: 00 to 12, D: 2 to 12, E: 4-12, F: 7 to 12<br>AS4059 Rev F, Table 1 Size Codes 2-12<br>AS4059 Rev F, Table 2 Size Codes cpc<br>[000 to 12, 00 to 12, 00 to 12, 2 to 12, 4 to 12, 7 to 12]<br>GBT14039 Codes 8-24<br>GJB420B Size Codes, A: 000 TO 12, B: 00 to 12, C: 00 to 12, D: 2 to 12, E: 4-12, F: 7 to 12<br>Please Note: Lower Limits are Test Volume dependent |
| Calibration                        | Individually calibrated with ISO Medium Test Dust (MTD) based on ISO 11171, on equipment certified by I.F.T.S. ISO 11943   |
| Moisture & Temperature Measurement | % RH (Relative Humidity) $\pm 3\%$ and fluid temperature $\pm 3^{\circ}\text{C}$ ( $\pm 5.4^{\circ}\text{F}$ )<br>Mineral Oil / Diesel version only  |
| Accuracy                           | $\pm \frac{1}{2}$ ISO code for 4, 6, 14 $\mu\text{m}_{(c)}$<br>$\pm 1$ code for 21, 25, 38, 50, 70 $\mu\text{m}_{(c)}$   |

### 4.2 Electrical interface

|                       |  |
|-----------------------|--|
| Supply Voltage        | 18-19V DC  |
| Supply Current        | 2.65A  |
| Power Consumption     | Charging state: ~40W max<br>Idle State: 3W max<br>Note: Power consumption level can vary dependant on fluid properties                       |
| Test Time             | Test volumes programmable by end user.<br>Pre-set volumes also available.  |
| Data Storage          | Approximately 4000 timestamped tests in the integral LPA3 memory   |
| Keypad & LCD          | 10.1" Capacitive touchscreen display with on board QWERTY keyboard<br>1024x600 pixels  |
| Communication Options | 2 USB output ports<br>1 x USB B type for direct connection to PC and software<br>1 x USB A type for direct data download to USB memory stick |

# TECHNICAL SPECIFICATION

## 4.3 Physical attributes

|                        |   |
|------------------------|---|
| Dimensions             | 435 mm / 17.12" (W) x 155 mm / 6.10" (D) x 292 mm / 11.49" (H)  |
| Weight                 | 10 kg / 22 lbs  |
| Hydraulics Connections | INLET M16x2 test point<br>OUTLET Quick release coupling   |
| Seal Material          | M/N Version - Viton®<br>(contact MP Filtri for any fluids that are incompatible with stated material)<br>S Version - Perfluoroelastomer (FKM) |

## 4.4 Fluid characteristics

|                     |   |
|---------------------|---|
| Fluid compatibility | M version - Mineral oil and synthetic fluid<br>N version - M type fluids & Subsea fluids and water based fluids (*)<br>S version - M & N type fluids & phosphate esters and aggressive fluids (*) |
| Viscosity           | Up to 400 cSt   |
| Fluid temperature   | +5°C (41°F) to +80°C (+176°F)   |
| Sample volume       | Maximum 100 ml / 3.38 fl oz per pump stroke<br>Test volumes programmable by end user<br>Pre-set volumes also available  |
| Minimum pressure    | 2 bar / 29 psi  |
| Maximum pressure    | 420 bar / 6092 psi static   |

(\*) **N** and **S** version, moisture sensor (W) not available

Available with Screen Protector (Part number 63.095000). Consult your local branch for further details

## 4.5 Environment

|                             |                                   |
|-----------------------------|-----------------------------------|
| Ambient working temperature | -10°C (+14°F) to +80°C (+176°F)   |
| IP Rating                   | IP66 (Lid close), IP54 (Lid open) |

## 4.6 Dimensions

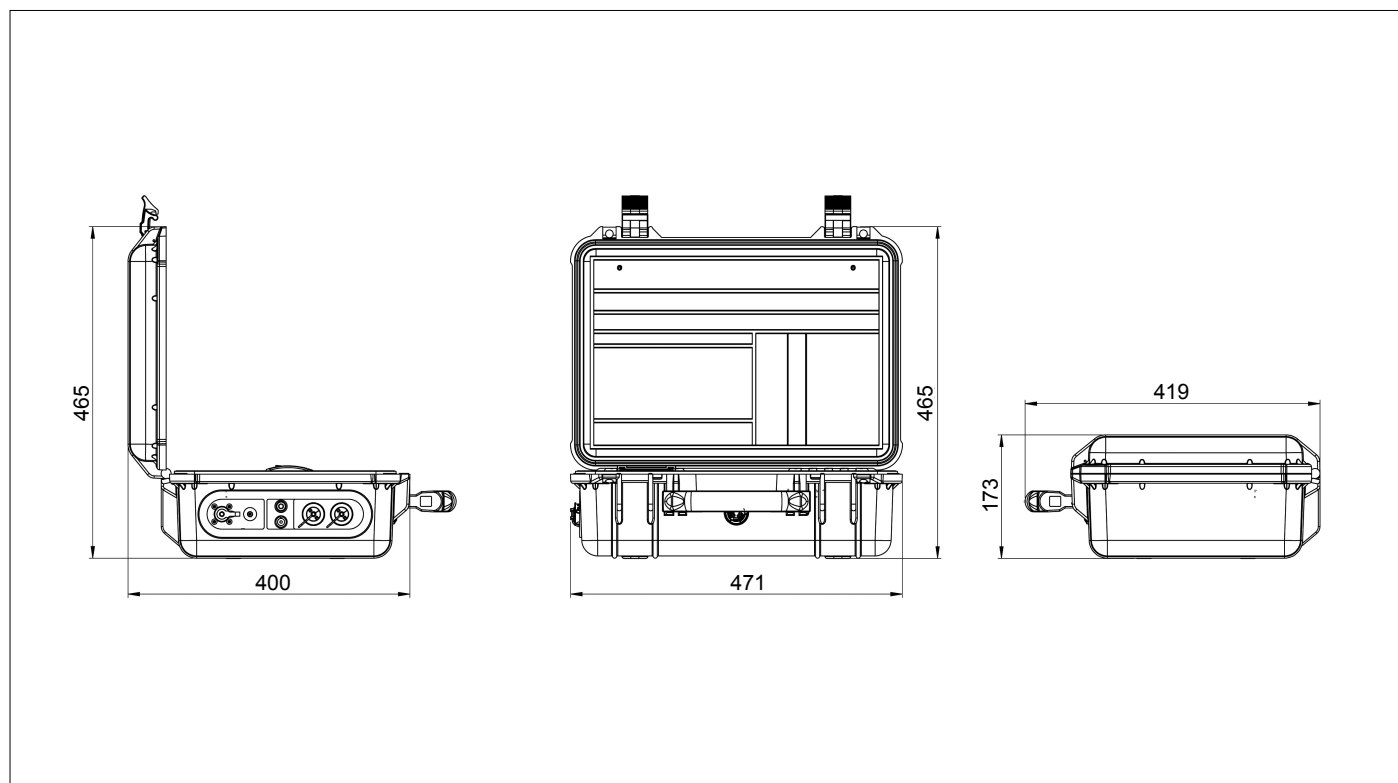

## 4.7 Designation & Ordering code

### AUTOMATIC PARTICLE COUNTER LPA3

| Series  | Configuration example: | LPA3 | W | P | M | 0 | 0 | 1 |
|---|------------------------|------|---|---|---|---|---|---|
| <b>LPA3</b> Light extinction particle counter                           |                        |      |   |   |   |   |   |   |
| <b>Moisture Sensor</b>  |                        |      |   |   |   |   |   |   |
| <b>0</b> Without moisture and temperature sensor                        |                        |      |   |   |   |   |   |   |
| <b>W</b> With moisture and temperature sensor                           |                        |      |   |   |   |   |   |   |
| <b>Pressure Sensor</b>  |                        |      |   |   |   |   |   |   |
| <b>0</b> Without on-screen inlet pressure display                       |                        |      |   |   |   |   |   |   |
| <b>P</b> With on-screen inlet pressure display                          |                        |      |   |   |   |   |   |   |
| <b>Fluid compatibility</b>  |                        |      |   |   |   |   |   |   |
| <b>M</b> Mineral oil and synthetic fluid                                |                        |      |   |   |   |   |   |   |
| <b>N</b> M type fluids & Subsea fluids and water based fluids (*)       |                        |      |   |   |   |   |   |   |
| <b>S</b> M & N type fluids & phosphate esters and aggressive fluids (*) |                        |      |   |   |   |   |   |   |
| <b>External Result Option</b>   |                        |      |   |   |   |   |   |   |
| <b>0</b> Without on board printer                                       |                        |      |   |   |   |   |   |   |
| <b>1</b> With on board printer  |                        |      |   |   |   |   |   |   |
| <b>Design Reference</b>   |                        |      |   |   |   |   |   |   |
| <b>0</b> Std option with full accessory kit and carry bag               |                        |      |   |   |   |   |   |   |
| <b>Country Plug Type</b>  |                        |      |   |   |   |   |   |   |
| <b>1</b> UK, EU, US, AUS/CN   |                        |      |   |   |   |   |   |   |

(\*) **N** and **S** version, moisture sensor (**W**) not available

Available with Screen Protector (Part number 63.095000). Consult your local branch for further details

# TECHNICAL SPECIFICATION

## 5. Product Installation and General Operation

### 5.1 Installation

Each LPA3 supplied consists of the following:

- 1 x LPA3 (\*)
- 1 x M16x2 microbore pressure hose, 1500mm long + pouch
- 1 x 2000mm quick release waste hose + pouch
- 1 x 1L waste receptacle
- 1 x Power adapter
- 1 x (each) UK/EU/US/CN/AUS power cable
- 1 x USB A-B Cable
- 1 x USB Stick with digital copies of Product User Guides, LPA-View software, accessory products, drivers and product brochures
- 2 x hard copy of calibration certificate
- 5 x Thermal printer paper
- 1 x Carry bag

(\*) Specific model will be as per ordered item

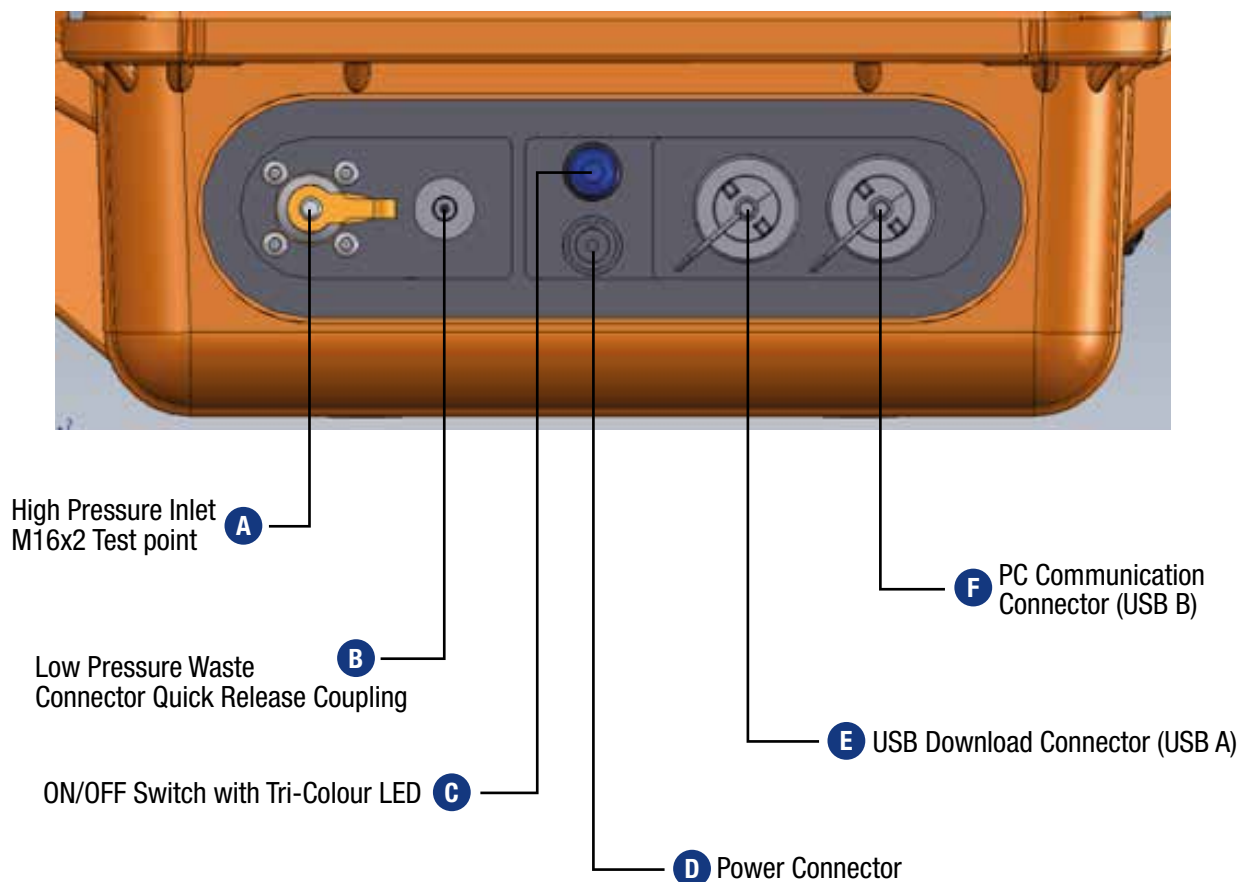

### 5.1.1 Physical procedure

NOTE: Unit features are turned off as factory standard. This includes the automatic print, moisture sensor test (if applicable). Should any of these be required they MUST be switch on prior to performing an analysis, please consult the relevant section of the operators guide on how to action this.

- Locate/decide on tapping point into the hydraulic circuit and ensure it is fitted with an M16x2 pressure test point.

If modifying the hydraulic system, ensure all pressure has been removed and the system isolated.



NOTE

- **B** Remove the waste cap from the low-pressure waste connector on the side of the unit.  
Note: this is done by pushing back the collar on the quick release fitting, this will free the waste plug

Do not pull on the orange retaining strap or the plug itself. This will cause damage to the plug and affect its functionality



NOTE

- Locate and remove the waste hose from the kit and decouple the mating fittings
- **B** Connect the waste hose to the LPA3 by pushing back the collar on the quick release fitting and inserting the male end of the waste hose. Note: ensure the male fitting is pushed fully home and that the collar has secured itself back in place.
- Place the opposite end of the waste hose into a suitable receptacle to collect the outgoing fluid. Note: it is advisable to utilise the supplied waste container for the initial purge of the unit (to remove previously sampled fluid to avoid cross contamination of fluids and samples). Once the initial purge is complete, the waste hose should be returned to the sample reservoir (where possible).

Do NOT connect the waste hose to a pressurized system. This will cause the LPA3 to malfunction and could cause internal damage. There must be no extra restriction placed on the waste hose, this must be vented to atmosphere.



NOTE

- Locate and remove the M16x2 microbore pressure hose from the kit and remove the caps
- **A** Remove the cap from the M16x2 test point on the LPA3
- **A** Connect one end of the pressure hose to the test point. Ensure that this is fully engaged before proceeding to the next step.
- Connect the other end of the hose to the M16x2 hydraulic test point of the system being tested
- The product can now be subjected to system pressure safely.

# PRODUCT INSTALLATION

## 5.1.2 Electrical interface

**C** The power on/off button is located at the side of the unit, see Figure 5.1.

Pressing this will cause the LPA3 to switch ON and startup screen will show on the display, see Figure 5.2.

The button also contains a Tri colour LED that will show the status of the unit relating to the amount of charge left in the battery, colour denotations are shown below:

Green - Higher than 70% level of charge remaining

Yellow - Between 20-70% charge

Red - Below 20% charge

**D** The charging port for the internal lithium ion battery is located directly below the power switch. To engage the power connector, you must align the white arrow on the cable connector with the white line at the top of the chassis plug on the device itself. One should engage this fully and then rotate approximately 60° clockwise. Reverse this action to remove the power charge cable.

Note: The LPA3 status of 'charging' is shown by a flashing LED.

**F** The LPA3 is designed as a standalone portable unit. However, if you wish to connect the product to a computer and utilise the product with its LPA-View software then this can be done via a standard A to B USB cable (this is provided with the unit).

The cable is plugged in to the forward most USB connector as shown in the image above (figure 6.1). The other end of the cable can then be connected to a PC that has MP Filtri's bespoke LPA View software loaded for communication/log download/remote control.

Please see document 200.054 for further information on using the LPA-View software.

**E** There is also an option to expedite the log download direct to a USB memory stick. An FAT32 formatted memory stick can be plugged to the 'A type' connector located on the side of the unit, to the left of the PC connection.

To ensure IP rating of the product is always met, caps for the USB connection  
MUST be reconnected after use



NOTE

## 5.2 General operation

### 5.2.1 Physical checks

- Oil leaks on and around the unit
- Fatigue in hoses and pipework that might then leak when under system pressure

### 5.2.2 Front panel operation and calibration due date

When the unit is first turned ON, the flash screen shown in figure 5.2 will appear.

The due date for recalibration of the product is stated in the center of the screen. This can also be found in the settings page of the unit.

To progress to the main user screen, select the arrow in the bottom right corner of the screen.



Figure 5.2 - LPA3 Flash Screen

# PRODUCT OPERATION

## 5.2.3 Home Screen

Note: upon initial start-up, the Home screen will be blank until tests have been completed. Once test results are present in the product memory, the home screen will be laid out in the following manner.

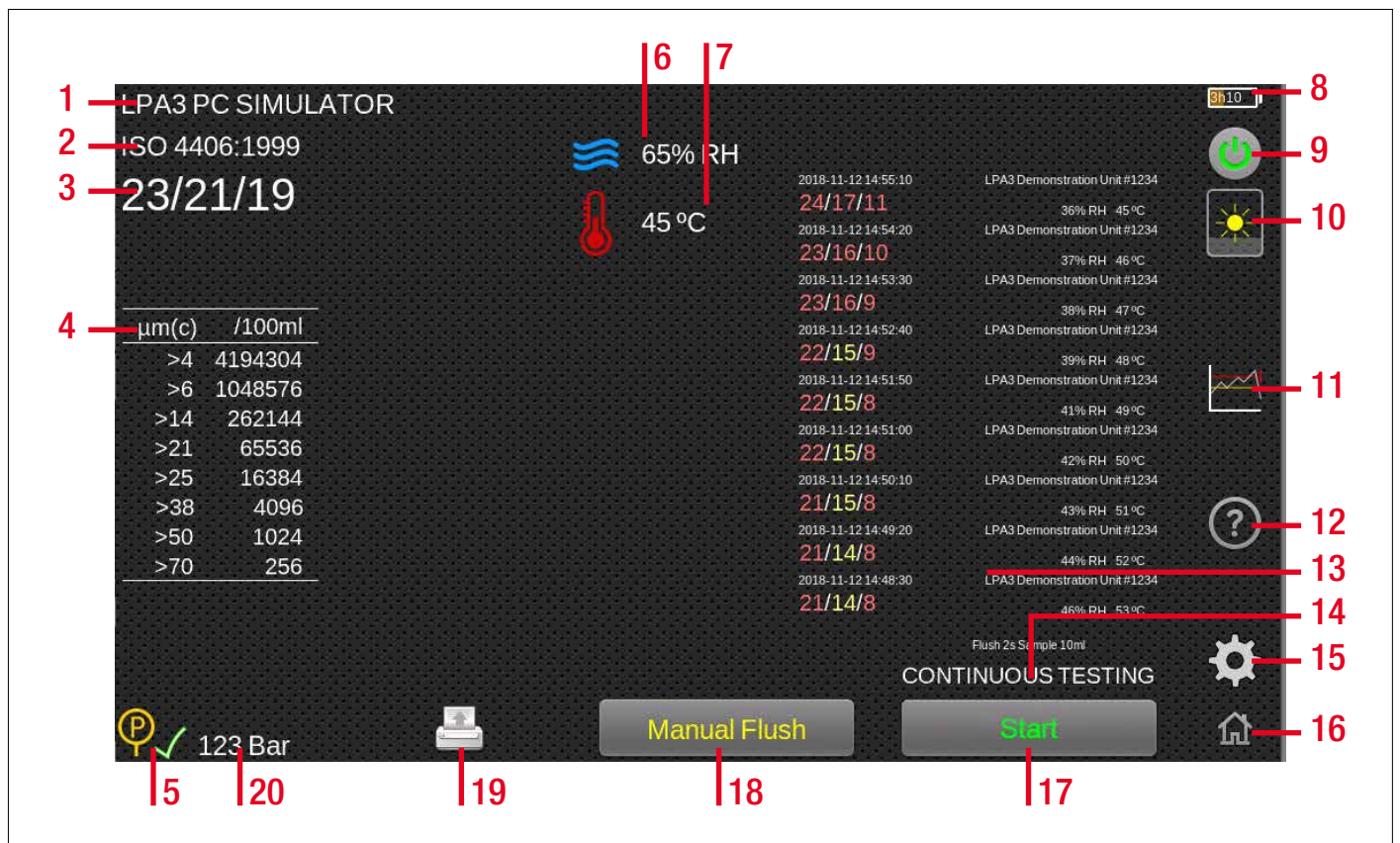

Figure 5.3 - LPA3 Home Screen

### Items:

- |                                     |                                      |
|-------------------------------------|--------------------------------------|
| 1. Test Reference Icon              | 13. Historical results section       |
| 2. Test Format Icon                 | 14. Test Type Icon                   |
| 3. Last Test Result                 | 15. Settings Icon                    |
| 4. Detailed Results Viewer          | 16. Home Icon                        |
| 5. Sufficient Pressure Icon         | 17. Test Start/Stop operation button |
| 6. RH Result                        | 18. Manual flush operation button    |
| 7. Temperature Result               | 19. Printer icon                     |
| 8. Battery Status Charge            | 20. Live pressure reading            |
| 9. Power Icon                       |                                      |
| 10. Contrast Slider Icon            |                                      |
| 11. Cleanliness level settings Icon |                                      |
| 12. Quick Help Icon                 |                                      |

## 5.2.4 Test reference icon

**Item 1, fig. 5.3.** Programming of the test reference can be done by pressing the test reference icon. Here you can change the test reference as required, up to 31 characters.

To confirm any changes, you must select “OK” via the green tick icon. To ignore any changes made; either select “CANCEL” via the red X icon, alternatively, the home screen icon in the bottom left corner can also be used (item 16, figure 5.3).



Figure 5.4 - Test Reference Screen

## 5.2.5 Test format icon

**Item 2, fig. 5.3.** Selecting the test format icon will open a new screen, (fig. 5.5), where the result format can be changed. When changing the format, the desired format must be selected and then the tick icon in the bottom right corner pressed to confirm.

NOTE: at the time of publication the GOST reporting format was not yet written/live. Images are for indicative purposes only.

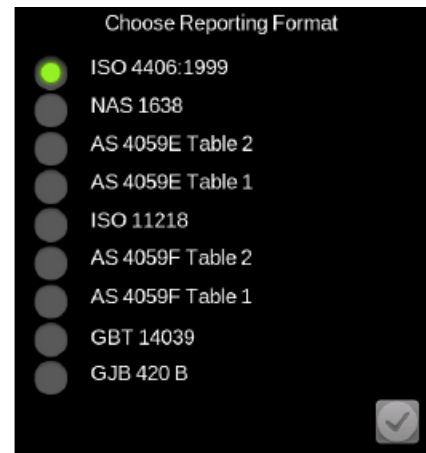

Figure 5.5 - Reporting Format Screen

## 5.2.6 Last test result

**Item 3, fig. 5.3.** This is where the last test result is shown. If no tests have been carried out since the unit has been turned on, then -/- will be displayed.

## 5.2.7 Detailed results viewer

**Item 4, fig. 5.3.** This area shows the detailed counts information for the last test result. Pressing on this area will scroll between detailed counts and graphical representations of the reporting format that the result was carried out in.

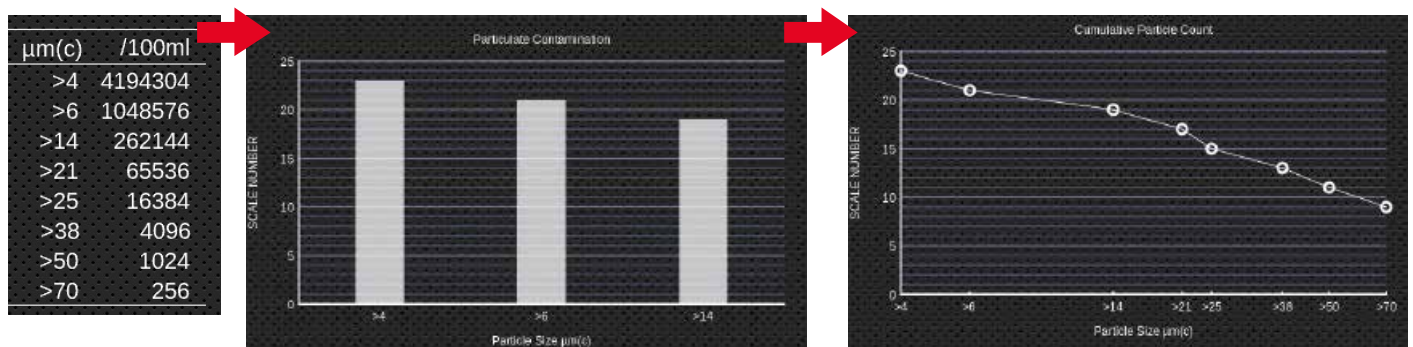

Figure 5.6 - Different Detailed Results Views

# PRODUCT OPERATION

## 5.2.8 Pressure readout

**Item 5, fig. 5.3.** Denotation of sufficient/insufficient pressure at time of test is given as a green tick icon or a red X icon respectively.



Figure 5.7

## 5.2.9 RH result

**Item 6, fig. 5.3.** If the product has the optional water sensor fitted (W version), then the last RH test result will be displayed here. The W sensor can be enabled/ disabled in the settings screen as detailed in section 5.3.6

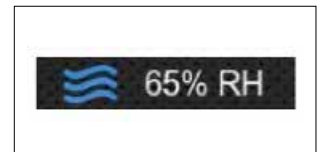

Figure 5.8

## 5.2.10 Temperature result

**Item 7, fig. 5.3.** If the product has the optional water sensor fitted (W version), then the last temperature result taken will be displayed here.

The W sensor can be enabled/ disabled in the settings screen as detailed in section 5.3.6.

Pressing the temperature result, will alternate the reading between degrees Centigrade and Fahrenheit.

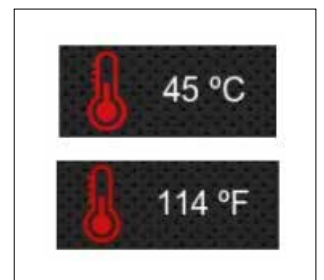

Figure 5.9

## 5.2.11 Battery status charge

**Item 8, fig. 5.3.** The charge percentage level is shown here in the top right corner of the home screen. The colour of the battery matches that of the LED:

Green - Higher than 70% level of charge remaining

Yellow - Between 20-70% charge

Red - Below 20% charge

The graphic also shows an estimated time associated with the charge remaining in the battery.



Figure 5.10

## 5.2.12 Power icon

**Item 9, fig. 5.3.** Pressing this button turns off the unit (this can also be done by pressing the physical switch on the side). When the unit is charging, selecting this icon will put the unit into standby mode where a battery symbol in the middle of the screen will show the current level of charge (fig. 5.12).

The icon will also be shown on the standby screen and can be used to access the home screen.



Figure 5.11



Figure 5.12

### 5.2.13 Contrast slider icon

**Item 10, fig. 5.3.** Sliding your finger up and down the icon will respectively increase and decrease the display brightness. Tapping the icon will change the brightness to the point where it is tapped.

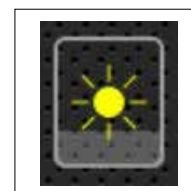

Figure 5.13

### 5.2.14 Cleanliness level settings icon

**Item 11, fig. 5.3.** This icon allows access to setting of the alarm levels associated with the selected reporting format.

Alarms can be set on combinations of cleanliness codes, water content and temperature. The available codes, and their interpretation, vary according to the set test Format. For example, it is possible to set a threshold of “NAS 11” or “ISO 18/16/15” or “AS4059E 8B-F”, etc.

In general, there are upper and lower limits that can be set for the cleanliness level, also for water content and temperature if applicable. An alarm, if enabled, will become active if any of the associated (upper/lower) limits are exceeded. However, if a field is left empty (blank) this is interpreted as a “don’t care” setting.

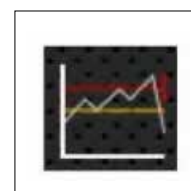

Figure 5.14

### ISO 4406 / GBT 14039 alarm levels

ISO 4406 represents cleanliness using codes for the number of particles greater than 4, 6 and 14  $\mu\text{m}_{(c)}$ .

These codes can be used as limits for the alarms by selecting the ISO 4406 test Format and then entering values as required (fig. 5.15).



Figure 5.15

# PRODUCT OPERATION

## NAS1638 alarm levels

NAS1638 can be used by selecting this as the test Format. The headings and boxes for the available settings change appropriately. NAS1638 represents the overall cleanliness level as a single code, this being the highest of the individual codes generated for each defined particle size. Hence, we have the option of setting a limit on this overall contamination class (the Basic Class), or we can set individual limits on any combination of the classes for the defined particle size ranges (fig. 5.16).

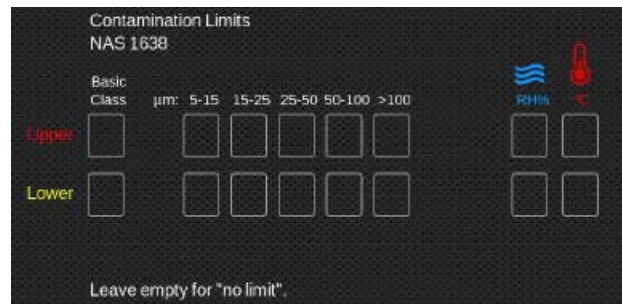

Figure 5.16

## AS4059E table 2 / AS4059F table 2 alarm levels

AS4059E Table 2 uses letters instead of numbers to indicate the particle size range, so the settings are labelled appropriately. The standard specifies ways to represent a cleanliness level using only a subset of the available particle sizes, for example B-F. The user can achieve this by only entering settings for the sizes desired, leaving the others empty. So, a limit of AS4059 7B-F could be represented simply by entering a value of 7 for B, C, D, E and F.

AS4059F Table 2 is identical except the letters have been replaced by the numerical particle size values (fig. 5.17).

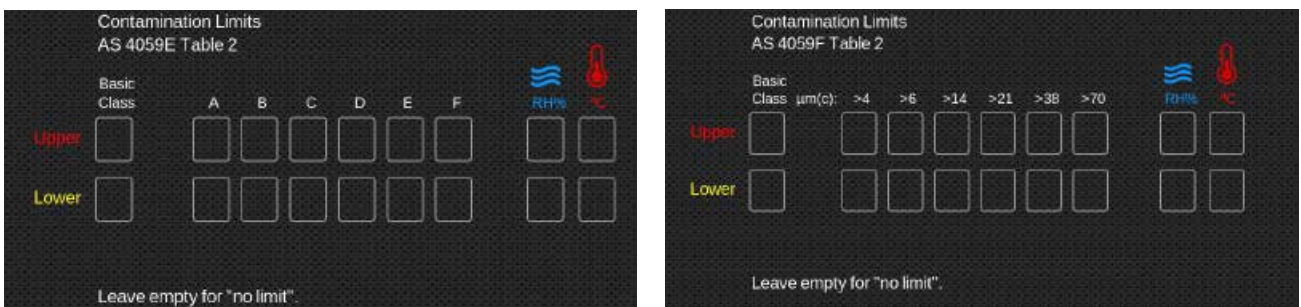

Figure 5.17

## AS4059E table 1 / ISO 11218 / AS4059F table 1 / GJB 420 B alarm levels

These four standards are similar except for terminology and reporting format. The actual numeric sizes and class thresholds are the same. Should an alarm exceed the programmed level, the corresponding format will show in the appropriate code/class (fig. 5.18).

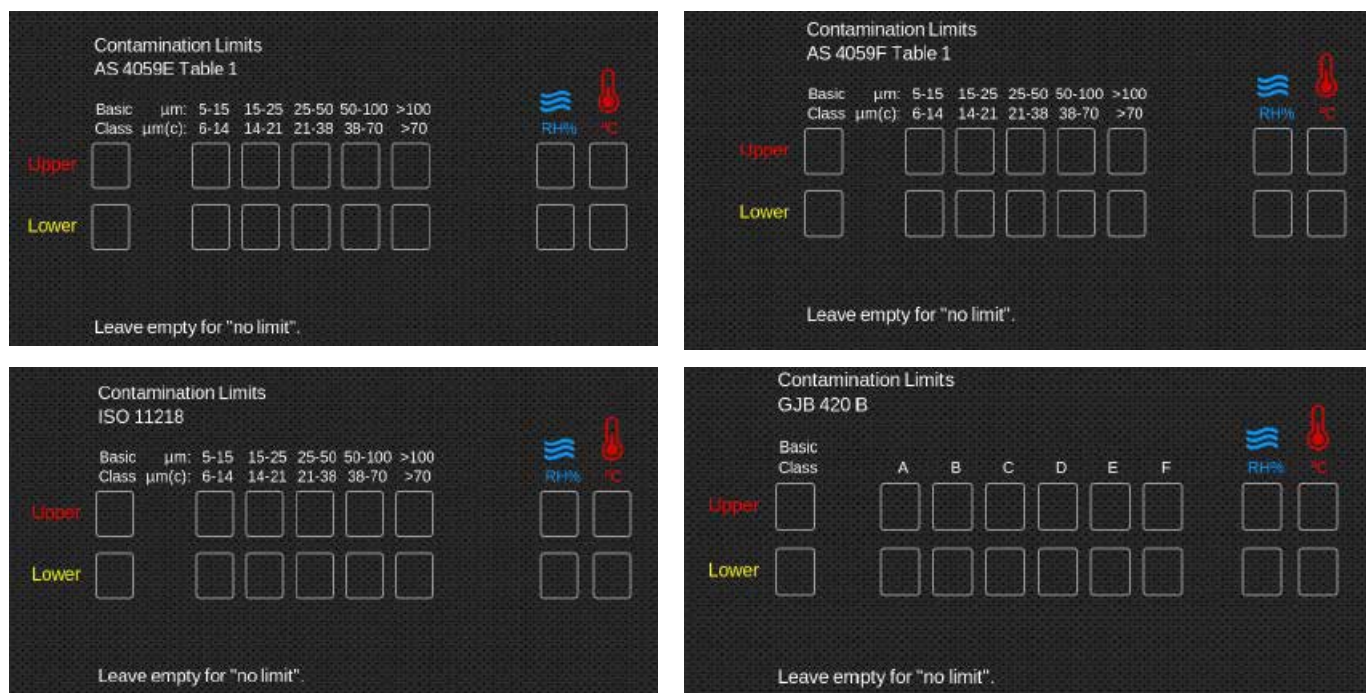

Figure 5.18

### 5.2.15 Quick help icon

**Item 12, fig. 5.3.** Selecting this brings up a quick help screen, this details quick tips and common problems faced.



Figure 5.19

### 5.2.16 Historical results section

**Item 13, fig. 5.3.** This section relates to all results run on the unit. Each result details the time/date, test reference, output of the test, plus any alarm results (if they had been programmed at the time of test). Should a result be pressed, the detailed counts/graphical representations will be for the test selected.

Note: the screen is now locked to the Historical data, and is denoted by the following warning sign in the bottom central section of the display.



Figure 5.20

# PRODUCT OPERATION

To get to history select a test result from the home screen

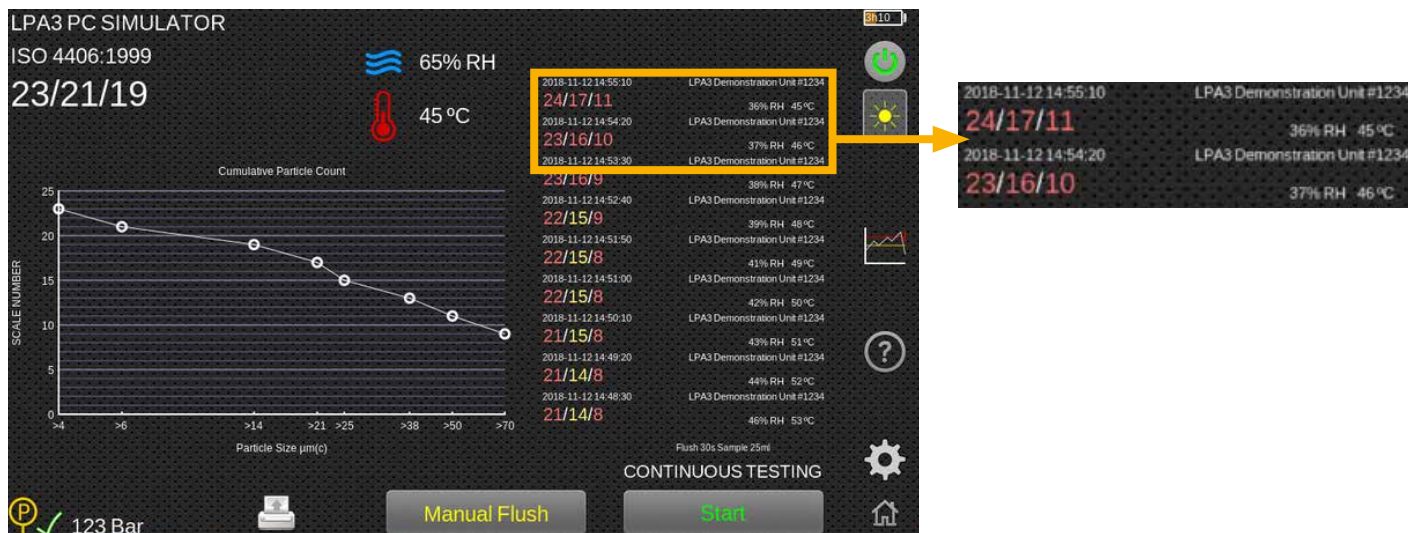

Figure 5.21

If the unit is running a test, the screen will not update until the History screens have been closed. To action this, simply press the image above, this will return the display to the 'live' readings.

## 5.2.17 Test type icon

**Item 14, fig. 5.3.** By selecting the test type icon (press on the text of the test type), will activate the test type election screen. Here you can change what type of test is performed, once selected, the test type automatically changes and defaults back to the main user screen.

**Normal test:** the LPA3 runs a test (based on the other parameters selected see section 5.3.3.1) and when the pump has returned to the start position the cycle stops. See section 5.3.3.1 for how to set a Normal test.

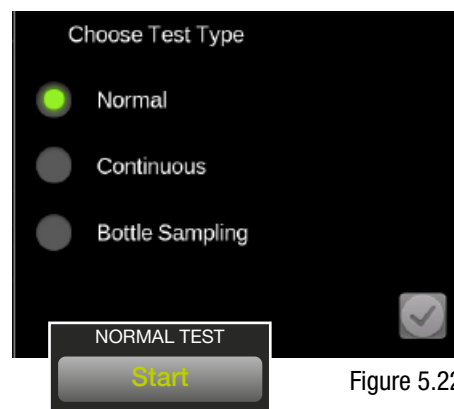

Figure 5.22

**Continuous testing:** the LPA3 runs a test (based on the other parameters selected), on the emptying stroke the flush valve opens. When the pump returns to the start position the cycle will either stop or automatically repeat the test, according to the specified test Interval/parameters selected. See section 5.3.3.2 for how to set a continuous test.

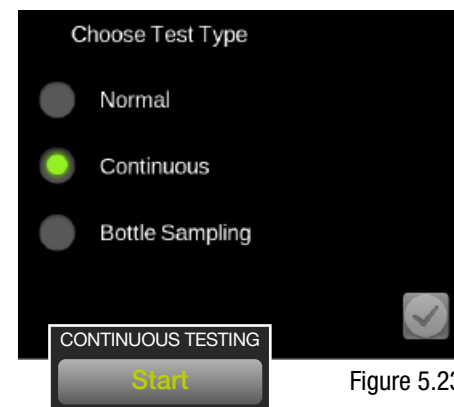

Figure 5.23

**Bottle sampling:** the test volume selected is defined by end user, when the pump returns to the start position the cycle stops.

See section 5.3.3.3 for how to set a Bottle sampler test.

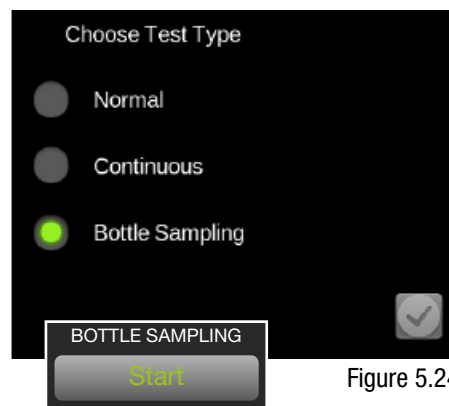

Figure 5.24

It is imperative that the sample volume be set up to suit the size of sample bottle being used. Access to the settings screen should be actioned to aid this set up.



NOTE

### 5.2.18 Home icon

**Item 16, fig. 5.3.** This icon shows in all screens. Selecting this at any point will revert the unit to the home screen.



Figure 5.25

### 5.2.19 Test start/stop operation button

**Item 17, fig. 5.3.** Selecting this icon will start a test based on the parameters defined by the other icons.

During a test the icon will 'fill' to show how much of the sample volume has been performed.

During a test the text will change to 'Emptying' and the icon will 'fill' to show how much of the emptying cycle has been performed.

Pressing the button during any part of either the Sample or Empty cycle will immediately stop the test at this point, the pump will not automatically return to the idle position.

If another test is started the pump will have to initially 'home' to fully empty the pump. The icon will show 'homing' whilst the pump is purging and returning to the idle position.



Figure 5.26



Figure 5.27



Figure 5.28



Figure 5.29

# PRODUCT OPERATION

## 5.2.20 Manual flush operation button

**Item 18, fig. 5.3.** Selecting this icon will open the flush valve and allow a free flow of fluid through the unit. This allows for any previously used fluids to be purged from the hoses and the unit itself, thus reducing the risk of cross contamination as well as providing relevant fluid that is more indicative of what is occurring within the system at the time of test. Whilst the flush cycle is running the text turns red and states 'Flushing' (see fig. 5.31). To close the flush valve, press the button again.

Note: the flush button is disabled during a test (including the auto flush part of the sequence). Should this cycle need to be stopped, press the Sampling button (fig. 5.27) to stop the test.

If the programmable auto flush is ignored i.e. set to zero, a manual flush will be required. If no flush is performed the pump will immediately start to draw fluid, this will include any previously tested fluid within the unit/hoses meaning the result will not be indicative of the system cleanliness.



Figure 5.30



Figure 5.31

A manual flush must be performed if the auto flush is not selected. Failure to flush/purge fluid from the unit and hoses will result in anomalous results and can affect the cleanliness reading achieved during the test.



## 5.2.21 Printer icon

**Item 19, fig. 5.3.** Tapping the printer icon will print the last test result in the result format currently displayed on the screen. This will only work for any tests carried out whilst the LPA3 has been turned on. If the LPA3 has been powered down for any reason, then the printer will not reprint the last result



Figure 5.32

The printer icon can also be used to reprint a previous test result in the history list. Select the required result and press the printer icon to print the specific test.

## 5.2.22 Live pressure reading

### Item 20, fig. 5.3.

If the product has the optional pressure transducer fitted, the live system reading will be shown here. Pressing the value will alternate between bar and psi readings



Figure 5.33



Figure 5.34

## 5.3 Settings icon

### Item 15, fig. 5.3.

Selecting this icon will bring up the settings screen. This will allow you to modify settings in further detail.

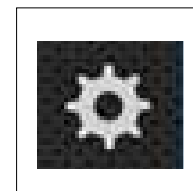
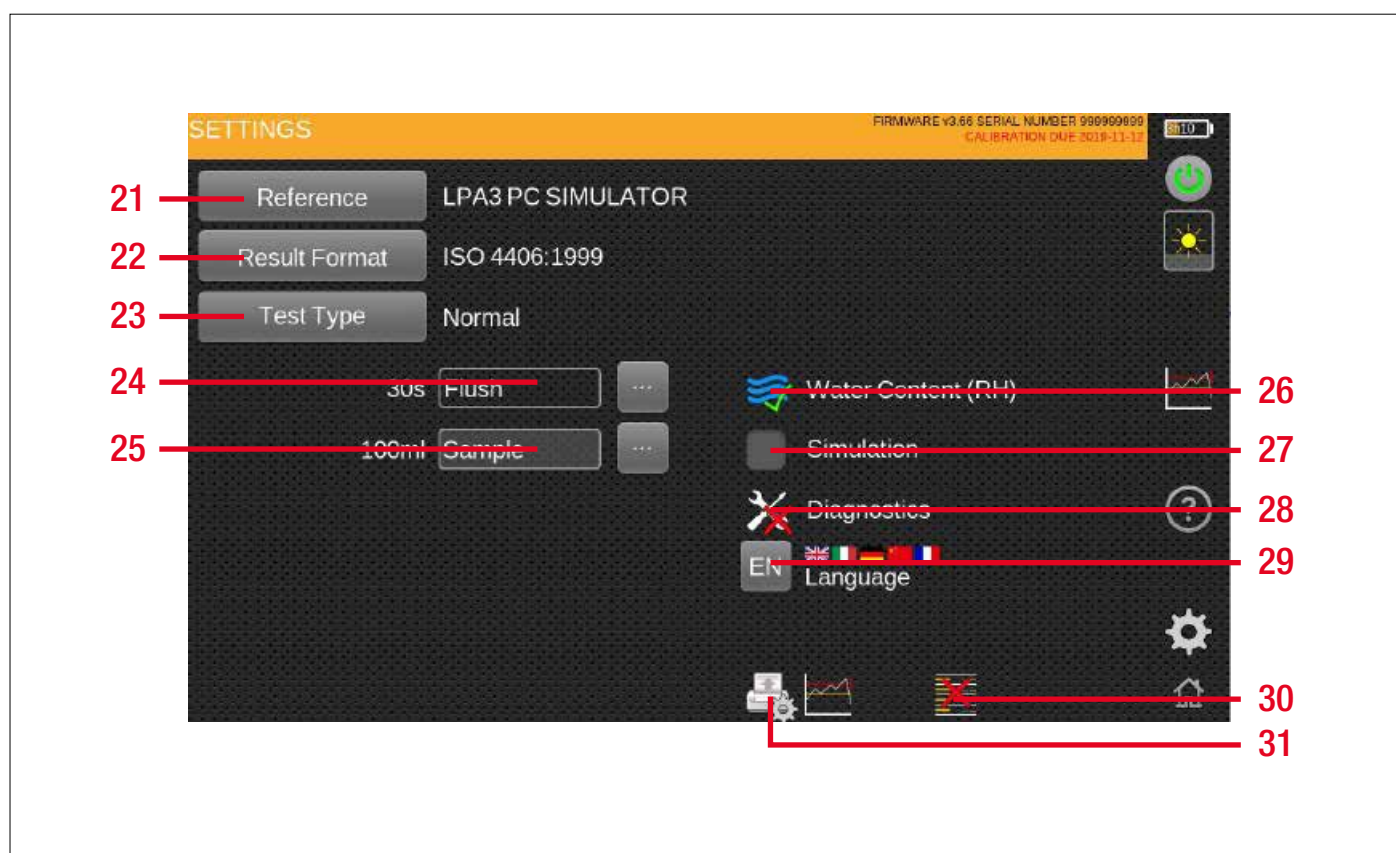

Figure 5.35



Setting screen - Figure 5.36

### Items:

- |     |                      |     |                         |
|-----|----------------------|-----|-------------------------|
| 21. | Test Reference Icon  | 27. | Simulation Enabled Icon |
| 22. | Result Format Icon   | 28. | Diagnostics Icon        |
| 23. | Test Type Icon       | 29. | Language icon           |
| 24. | Flush Time Slider    | 30. | Delete History icon     |
| 25. | Sample Volume Slider | 31. | Printer Settings Icon   |
| 26. | RH Test Enabled Icon |     |                         |

# PRODUCT OPERATION

## 5.3.1 Test reference

Item 21, fig. 5.36. See section 5.2.4.

## 5.3.2 Result format

Item 22, fig. 5.36. See section 5.2.5.

## 5.3.3 Test type

Item 15, fig. 5.3. See section below 5.3.3.1 and 5.3.3.3.

### 5.3.3.1 Normal test

If Normal test type is selected, options will appear associated with test setup:

#### Automated flush time

The slider bar can be used to set the required time for flushing (30 second intervals) or a time can be manually inputted via the keyboard option to the right of the slider



#### Sample Volume

The slider bar can be used to set the required time for flushing (25ml intervals) or a time can be manually inputted via the keyboard option to the right of the slider



### 5.3.3.2 Continuous test

If Continuous test type is selected, additional functions/parameters will appear in addition to the standard flush time and sample volume options.

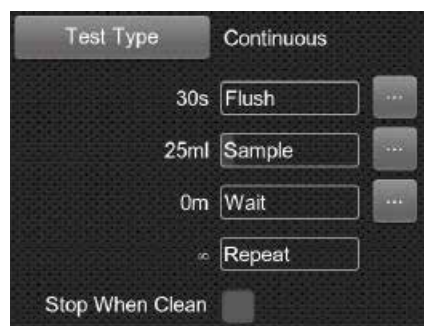

Figure 5.37

Wait function: this function will prompt the unit to restart a test after a defined time period, Figure 5.38. The slider bar can be used (5-minute intervals), Figure 5.39.



Figure 5.38



Figure 5.39

Alternatively, a time can be manually inputted via the keyboard, Figure 5.40

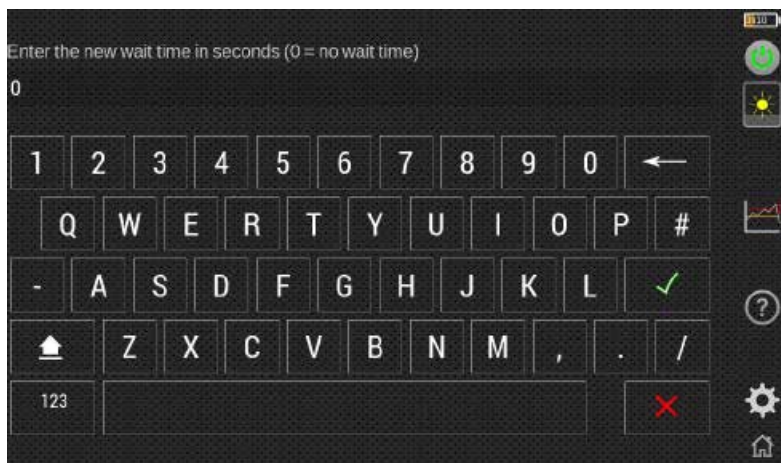

Figure 5.40

**Repeat:** This can be used to program the unit to perform a set number of tests and then stop testing. The slider bar can be used to set the required quantity



Figure 5.41



Figure 5.42

**Stop Testing When Clean:** This is a feature intended for cleaning rigs or “filter trolley” type applications. This requires the alarm levels for the relevant standards to be set see section 5.2.14. The LPA3 continues testing until the fluid is “clean”, at which point an alarm is signaled and testing stops. To select this option, activate the tick box



Figure 5.43



Figure 5.44

**Confirm Target Level before Stopping:** this helps to ensure that a test sequence is not terminated too soon, when there are still a few large particles in the system.

When selected, A new option will appear that allows a user defined number of confirmation tests to be run if required. The number in the box is how many successive “clean” results are needed before testing halts and can be set via the slider scale.

The LPA3 will now complete the selected number of confirmation tests, providing these are all within the set alarm level the unit will then stop testing.



Figure 5.45



Figure 5.46

Note: Alarm levels must be programmed for this selection to operate correctly

# PRODUCT OPERATION

## 5.3.3.3 Bottle sampling

If Bottle Sampling test type is selected, additional functions/parameters will appear in place of the options.

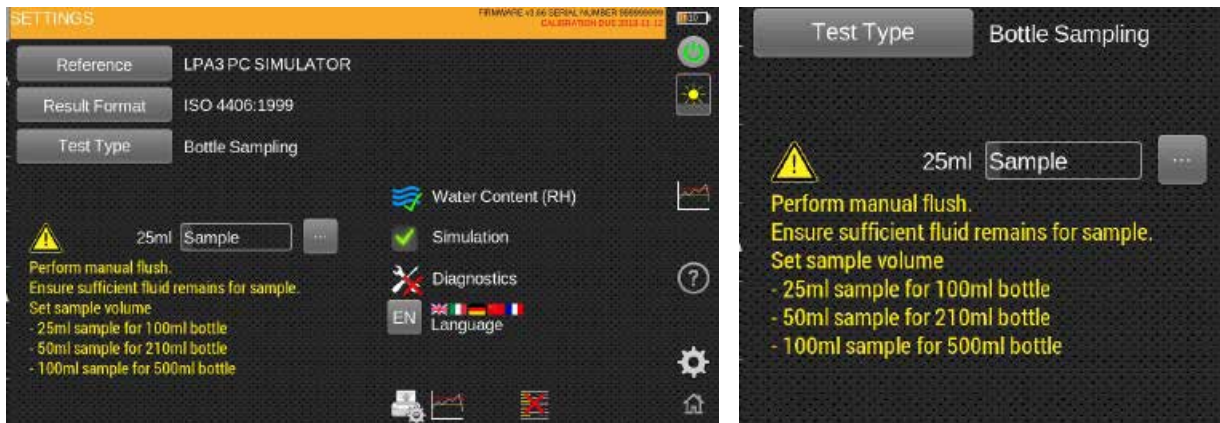

Figure 5.47

Recommended sample volumes are made on screen specific to sample bottle size. The slider scale should be used to define the sample volume and a manual flush of the fluid **MUST** be carried out.

Extreme care should be taken to ensure that there is enough fluid remaining in the sample bottle, this can be done visually through the clear sample chamber on the Bottle Sampling devices.

A manual flush must be performed for the Bottle Sampler test. Selection of this mode disables the auto flush sequence. Ensure that enough fluid remains for the programmed sample volume. Set sample volumes are suggestions from manufacturer.



## 5.3.4 Flush time

Item 24, fig. 5.36.

Sliding your finger left and right the icon will respectively decrease and increase the time that the unit will hold the flush valve open prior to a test. Tapping the icon will change the time to the point where it is tapped. The slider can be used to change the time between 30, 60 and 120s. This can also be changed manually by selecting the icon to the right of the slider (fig. 5.48).



Figure 5.48



Figure 5.49

### 5.3.5 Sample volume size

**Item 25, fig. 5.36.** Sliding your finger left and right the icon will respectively decrease and increase the test fluid volume.

Tapping the icon will change the volume to the point where it is tapped. The slider can be used to change the time between 25, 50 and 100ml. This can also be changed manually by selecting the icon to the right of the slider and typing the required volume (fig. 5.51).



Figure 5.50

### 5.3.6 Water content (RH)

**Item 26, fig. 5.36.** The option to perform a moisture content (RH) test will only be present if you have the W version of the product.

If the product has an RH sensor then this icon will show (if there is no RH sensor on the unit it will not appear). Tapping this icon will either enable or disable the RH sensor. This will remain the same until it is selected again and will not default back when the unit is turned off.

If the icon has a green tick, then the RH option is enabled and if a red X is showing then the RH option is disabled and will not show on the test result.



Figure 5.51



Figure 5.52

### 5.3.7 Simulation

**Item 27, fig. 5.36.** The simulation icon is mainly for demonstration purposes. If there is a tick present, then the simulation mode is enabled and when the test start icon is selected on the home screen the test process will run as a simulation on the screen. No physical operation of the internal components will occur. As with the RH icon, this will hold the setting if the product is turned off.

Note: if the unit is accidentally left in Simulate mode, a warning will flag on the top right-hand side of the user screen (fig. 5.54).



Figure 5.53

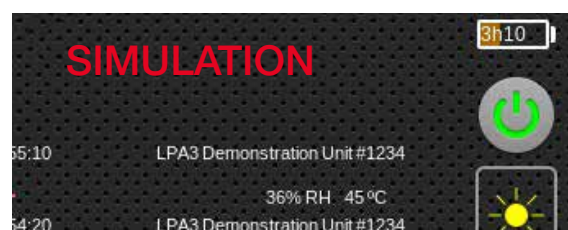

Figure 5.54

### 5.3.8 Diagnostics

**Item 28, fig. 5.36.** This icon is to view the diagnostics screen. This is not accessible by end user and is only for MP Filtri personnel.



Figure 5.55

# PRODUCT OPERATION

## 5.3.9 Language

**Item 29, fig. 5.36.** The LPA3 is equipped with multiple languages, the default language is set to English. To alter to a preferred language, press the language icon, a selection window will open.

Select the language required, the window will close, and the language will automatically change to your selection.



Figure 5.56

## 5.3.10 Delete history

**Item 30, fig. 5.36.** Pressing the delete history icon will erase all records held within the LPA3 memory. Before proceeding with the deletion, the unit will ask for confirmation, (fig. 5.59).

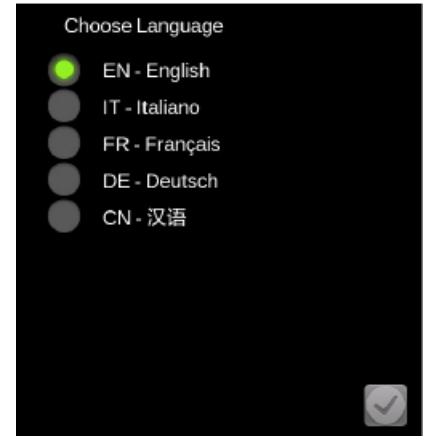

Figure 5.57

It is important to ensure/verify that your log results have been downloaded and saved prior to deleting from the unit. Once the test history has been deleted from the unit, it cannot be reversed, all history will be lost.



Figure 5.58

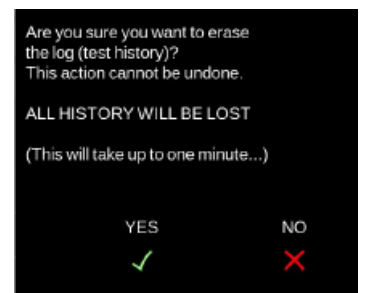

Figure 5.59

## 5.3.11 Printer icon

**Item 31, fig. 5.36.** This icon enables the user to modify the printer settings. Selecting the icon will bring up a new screen where each option can be selected or deselected (fig. 5.61).

These settings will save when the tick is pressed in the bottom right hand corner.



Figure 5.60

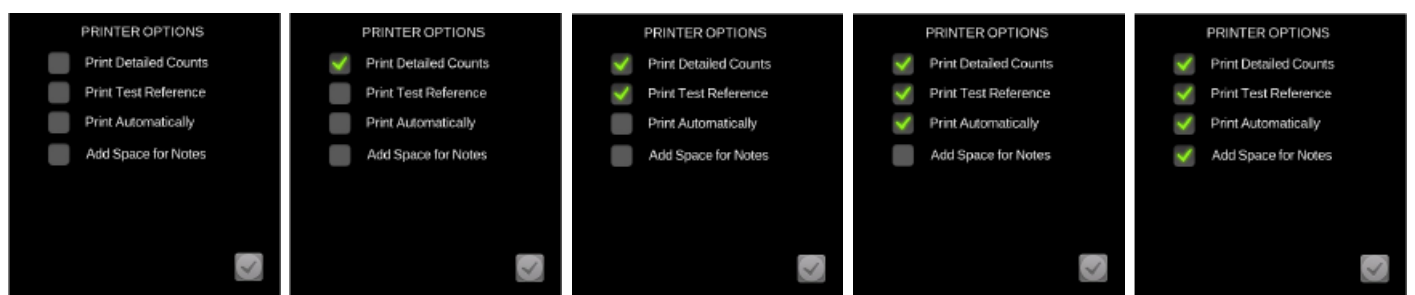

Figure 5.61

## 5.4 LPA3 removal and product maintenance

When removing the LPA3 from the system ensure the system pressure is shut off from the LPA3.

- Open the flush valve by selecting the manual flush button on the display
- Disconnect the high-pressure hydraulic hose from the M16x2 test point on the system
- **A** Disconnect the hose from the particle analyser HP connector

NOTE: there may be some residual oil in the hose when it has been disconnected, this must be cleaned and disposed of safely

- **B** Remove the waste hose from the waste connector by pulling back the outer collar.
- Allow any fluid to drain from the hose and then remove from the waste vessel

NOTE: Ensure any spillages are cleaned up and that all fluids are disposed of in accordance with local legislations

- Wipe away any residual oil from around the connectors in the LPA3 bulkhead and then replace the caps

## 5.5 Disposal

All LPA3 products are sent in a cardboard box with appropriate protective packaging and these should be recycled accordingly where possible.

Fluids used with the LPA3 should be fully drained and disposed of according to EU waste framework directive and ISO 44001 Environmental Management.

# PRODUCT OPERATION



# TROUBLESHOOTING / FAQ

## 6 Troubleshooting / FAQ

### 6.1 Misuse of Product

- The product should be connected to a power supply within the rating of the product and not wired directly to the mains.
- This product should be connected to a hydraulic line; this must be within the pressure range of the unit (<2 ÷ <420 bar).
- Connection hoses should never be allowed to lie along the floor when the LPA3 is installed and in use.
- The operator should follow all standard operating procedures previously set at the operating location as well as the procedures required by the manufacturer.
- The LPA3 is not suitable for use in an explosive environment or an ATEX zone.
- Over-tightening of test points/ hoses can damage threads causing the unit to fail.

### 6.2 Fault Finding

Unexpected results obtained from sample

- Check that the microbore pressure hose has been fully connected at both the system and LPA3 ends.
- High water / aeration levels
- Antifoam additive package within sample fluid

Remote Device dialogue not responding to buttons being pressed

- Check that correct COM port has been selected in the Remote Device dialogue.
- Check USB driver has been installed.
- Disconnect power supply to LPA3 and then reconnect it.

If the LPA3 has been subjected to excessive contamination and a blockage is suspected, a flush with a suitable fluid may clear the blockage.

The standard LPA3 is fitted with Viton seals, so Petroleum Ether or Iso Propyl Alcohol may be used for this purpose, in conjunction with the MP Filtri UK Bottle Sampling Unit. See flushing guidelines on supplied product USB.

DO NOT USE ACETONE

The data and information contained in this publication are provided only for the purpose of information.  
MP Filtri reserves the right to make changes to the models and versions of the products described at any time,  
both for technical and commercial reasons.

The colours and photographs of the products are purely indicative.  
Any reproduction, partial or total, of this document is strictly prohibited.  
Rights reserved.





## WORLDWIDE NETWORK

### HEADQUARTERS

**MP Filtri S.p.A.**  
Pessano con Bornago  
Milano  
Italy  
sales@mpfiltri.com

### BRANCH OFFICES

**ITALFILTRI LLC**  
Moscow  
Russia  
mpfiltrirussia@yahoo.com

**MP Filtri Canada Inc.**  
Concord, Ontario  
Canada  
sales@mpfiltricanada.com

**MP Filtri France SAS**  
Lyon  
AURA  
France  
sales@mpfiltrifrance.com

**MP Filtri Germany GmbH**  
St. Ingbert  
Germany  
sales@mpfiltri.de

**MP Filtri India Pvt. Ltd.**  
Bangalore  
India  
sales@mpfiltri.co.in

**MP Filtri (Shanghai) Co., Ltd.**  
Shanghai  
P.R. China  
sales@mpfiltrishanghai.com

**MP Filtri U.K. Ltd.**  
Bourton on the Water  
Gloucestershire  
United Kingdom  
sales@mpfiltri.co.uk

**MP Filtri U.S.A. Inc.**  
Quakertown, PA  
U.S.A.  
sales@mpfiltriusa.com

**PASSION TO PERFORM**



Phone: (603) 577-8707 –  
1 Chestnut St., Box 16, Suite  
340, Nashua, NH 03060 –  
sales@scindustrialsales.com

**SC INDUSTRIAL SALES**